

Replacing [®] RES-225/RES-445

Replacement Instructions



The RESISTRON temperature controller RES-445 can be used as an alternative to the RES-225 controller. The steps that are necessary to convert from RES-225-0-x (standard model without modifications) to RES-445 are described below. These instructions only provide a brief overview of the two controllers. If in doubt, please refer to the latest



version of the controller documentation, which is always binding. The conversion from controller types RES-2xx-1-x is not described here. Please contact ROPEX for further informations.

Comparison of RES-225 / RES-445

Dimensions

The front panel cutout dimensions of the RES-225 and RES-445 controllers are identical. The RES-445 fea-

tures a protective film to IP42 instead of the transparent hood. A transparent front cover featuring IP65 is available as a option.

| RES-225 | RES-445 |
|---|--|
|  |  |



Set point selection

| RES-225 | RES-445 |
|--|---|
| Selection by applying a 0...10VDC voltage to the analog input at terminals 16+17 (Corresponding to 0...300°C, RES-225-0-5: 0...500°C). | Selection by applying a 0...10VDC voltage to the analog input at the terminals 20+23 (Corresponding to 0...300°C or 0...500°C). |
| | |

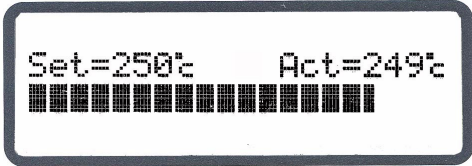

Temperature indication (actual value)

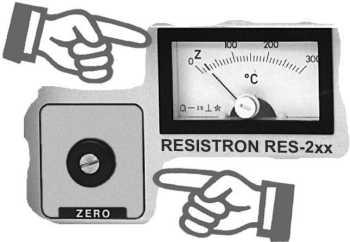
| | |
|---|---|
| <p>RES-225 Indication on a analog instrument (ATR-x)</p> | <p>RES-445 Indication on the 4-line display (dynamic bar and digital value).</p> |
|  |  |



Zero calibration

| | |
|--|--|
| <p>RES-225 Zero calibration by means of a 10-turn potentiometer. The pointer of the indicating instrument must be set to „Z“.</p> | <p>RES-445 Automatic zero calibration (AUTOCAL) with step 7 in the software menu.</p> |
|  |  |

Alarm output / reset

| | |
|--|---|
| <p>RES-225 Indicated by means of a red ALARM LED on the front panel. Reset by pressing the RESET key.</p> | <p>RES-445 Indicated on the display. The error is identified by a numeric code (☞ RES-445 documentation). Reset by pressing the RESET key ().</p> |
|  |  |

Manual mode

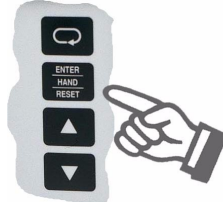
| | |
|--|---|
| <p>RES-225 Selected by pressing the HAND key. The red ON LED is lit continuously.</p> | <p>RES-445 Selected by pressing the HAND key () while the Home position is displayed.</p> |
|  |  |

Line frequency setting (50/60Hz)

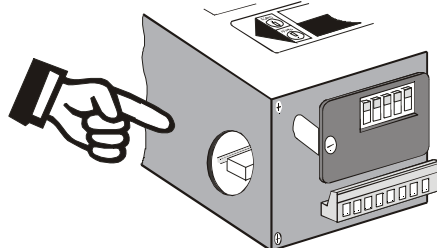
| | |
|--|--|
| <p>RES-225 Configured with plug-in jumper.</p> | <p>RES-445 Detected automatically in the 47...63Hz range.</p> |
|  | <p>Automatic detection</p> |

Installation and setup

! Installation and startup may only be performed by technically trained, skilled persons who are familiar with the associated risks and warranty provisions.

The information provided here offers no more than a brief overview. If in doubt, please refer to the latest version of the controller documentation, which is always binding (see also section „Safety and warning notes“ of the RES-445 documentation).

Proceed as follows to replace the RES-2xx controller and install/start up the RES-445:

1. Switch off the line voltage and verify the safe isolation from the supply.
2. Remove the existing RES-2xx controller.
3. The supply voltage specified on the nameplate of the RES-445 controller must be identical to the line voltage that is present in the plant or machine. The line frequency is automatically detected by the temperature controller in the range from 47 to 63Hz.
4. Set the DIP switches on the RES-445.

! The settings of the DIP switches on the RES-445 are NOT the same as on the RES-225. Please set these switches in accordance with the ROPEX Application Report in order to avoid malfunctions.

Old setting ranges on the RES-225:

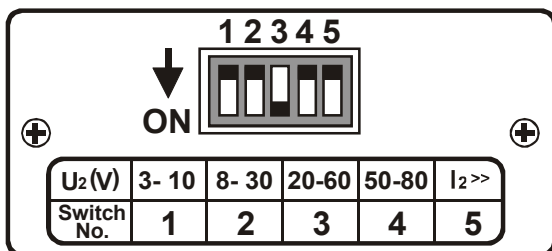

New setting ranges on the RES-445:

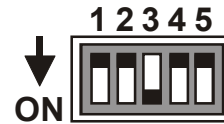

| | | | | | | |
|---------------|------|------|--------|--------|------------|-----------------------------------|
| DIP-SWITCH ON | 1 | 2 | 3 | 4 | 5 | I_2 (A) |
| U_2 (V) | 1-10 | 6-60 | 20-120 | OFF ON | OFF OFF ON | 30 - 100 60 - 200 120 - 400 |

The table below compares the two controllers. These settings can be taken as a guide (e.g. when the controller is started up for the first time):

| | RES-225 | RES-445 |
|-------|---------------|---------|
| | DIP switch ON | |
| U_2 | 1 | 1 |
| | 2 | 2 |
| | 3 | 3 |
| | 4 | 3 |
| I_2 | 5 | 4 |

5. Install the RES-445 controller in place of the RES-2xx.

! The terminals of the two controllers are NOT identical. The wiring must be changed according to the wiring diagram described in section "Wiring diagram of the RES-445" on page 8.

6. Switch on the line voltage.
7. A power-up message appears on the display when the controller is switched on to indicate that it has been started up correctly.

8. One of the following states then appears:

| DISPLAY | ACTION |
|--|---|
| Home position Shows the SET and ACTUAL temperatures and the dynamic bar | Go to 9 |
| Shows error code 104, 106, 109 or 211 | Go to 9 |
| Shows error code 101...103, 201...203, 801 or 9xx | Fault diagnosis (↪ RES-445 documentation) |

9. Select the language and reset the controller to the factory settings.

Press the key for at least 2s (to open the Configuration menu). Step 20 is displayed. Select the desired language with the keys. Confirm your selection by pressing . Press the key to display step 21 (factory settings). Press the key to confirm the factory settings (an acknowledgment message appears). Step 22 is displayed next.

10. Set the temperature range to 500°C
(Only if you have so far been using an RES-2xx-0-5 controller)

Then set "Alloy 20, max 500°C" with the keys in step 22. Confirm your selection by pressing .

11. Return to the Home position

Press the key for at least 2s (to return to the Home position or Alarm menu).

12. Calibrate the zero point

Activate the AUTOCAL function while the heat-sealing band is still cold.

Press the key repeatedly until step 7 is displayed. Then select the AUTOCAL function by pressing the key. If this function is executed correctly, the Home position is displayed again

automatically.

If the zero has not been calibrated successfully, an error message appears on the display. In this case the controller configuration is incorrect (↪ see section „Controller configuration“ of the RES-445 documentation and the ROPEX Application Report). Configure the controller correctly and repeat the AUTOCAL function.

13. Set the heatsealing temperature (select the set point)

The heatsealing temperature can be set on the RES-445 controller in two ways:

- By means of the setting menu step 1
- By applying a 0...10VDC voltage to the analog input at terminals 20+23

When substituting a RES-225 the analog input is used. Therefore the preset temperature in the setting menu step 1 must be set to 0°C.

This must be done as followed:

Press the key briefly (to display step 1 in the Setting menu). Set the temperature with the keys to 0°C. Confirm your selection by pressing . Press the key for at least 2s (to return to the Home position).

Preset the heatsealing temperature by applying a 0...10VDC voltage to the analog input at terminals 20+23 then. The set heatsealing temperature is displayed in the Home position.

Then activate the "START" signal (HEAT). The indication on the display (actual value and dynamic bar) permits the heating and control process to be observed:

If an error code is displayed, please proceed as described in section „Error messages“ of the RES-445 documentation.







The controller is now ready

Substituting a RES-225-0-5 (temporarily with MOD 16) in a PMB-UVA machine

! When substituting a RES-225-0-5 in a PMB-UVA machine the following additional guideline must be carried out in order to avoid malfunctions.

A RES-225-0-5 installed in a PMB-UVA machine has a special configuration for the temperature preset via the analog input (temporarily with MOD 16). A analog voltage of 0...6.66VDC is used for a temperature preset of 0...400°C. The new RES-445 uses a 0...10VDC voltage for presetting 0...500°C (↪ Section „Installation and setup“, point 10).

Because of this the following two guidelines must be carried out:

1. The maximum heatsealing temperatur of the RES-445 must be limited to 400°C as followed:
Press the  key for at least 2s (to open the Configuration menu). Step 20 is displayed. Press the  key repeatedly until step 23 is displayed. Then set "400°C" with the   keys. Confirm your selection by pressing . Press the  key for at least 2s (to return to the Home position or Alarm menu).
2. When applying a 0...10VDC voltage at the analog input in this application a correction factor of 1.2 must be used for recalculating the correct heatsealing temperature. This must be done via the temperature preset in the PLC terminal.

Sample:

When applying a voltage of 3.0VAC at the analog input of a temperature controller the old RES-225 has a set temperature of 180°C. The new RES-445 has 150°C only.

For a set temperature of 180°C a voltage of 3.6VDC (3.0VDC x 1.2) must be applied at the analog input of the RES-445. This will be done by a temperature preset of 216°C (180°C x 1.2) in the PLC terminal.

The following diagram shows the different tempera-

ture curves of the old RES-225 and the new RES-445:

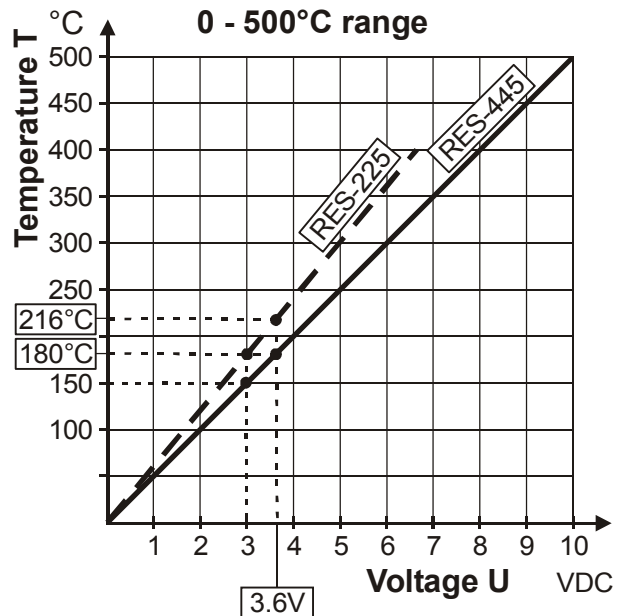

The following table shows some sample values for comparison:

| Function | RES-contr. sealing temp. | PLC Temp. preset for RES-225 | PLC Temp. preset for RES-445 |
|-----------|--------------------------|------------------------------|------------------------------|
| PRE-HEAT | 100°C | 100°C | 120°C |
| MAIN HEAT | 180°C | 180°C | 216°C |

! This are overview guidelines only. The machine documentation and the retrofiting documentation of the machine manufacturer are valid in order to avoid malfunctions.

RES-445 factory settings / as-delivered condition

If you accept the factory settings (step 21 in the software menu, see step 9 above), the following defaults are restored:

| Menu step | Function | Value |
|-----------|-------------------------|-----------------------|
| 1 | Heatsealing temperature | 0°C |
| 6 | Hold mode | OFF |
| 22 | Alloy/range | Alloy A20, max. 300°C |

| | | |
|----|---------------------|-----------------|
| 23 | Maximum temperature | 300°C |
| 30 | Cycle counter | 0 |
| 31 | Alarm relay | Closed by alarm |

The selected language (step 20 in the software menu) remains set regardless of the factory settings.

As-delivered condition:

The RES-445 controller is delivered with the above factory settings and with the language set to "German".

Wiring diagram of the RES-445

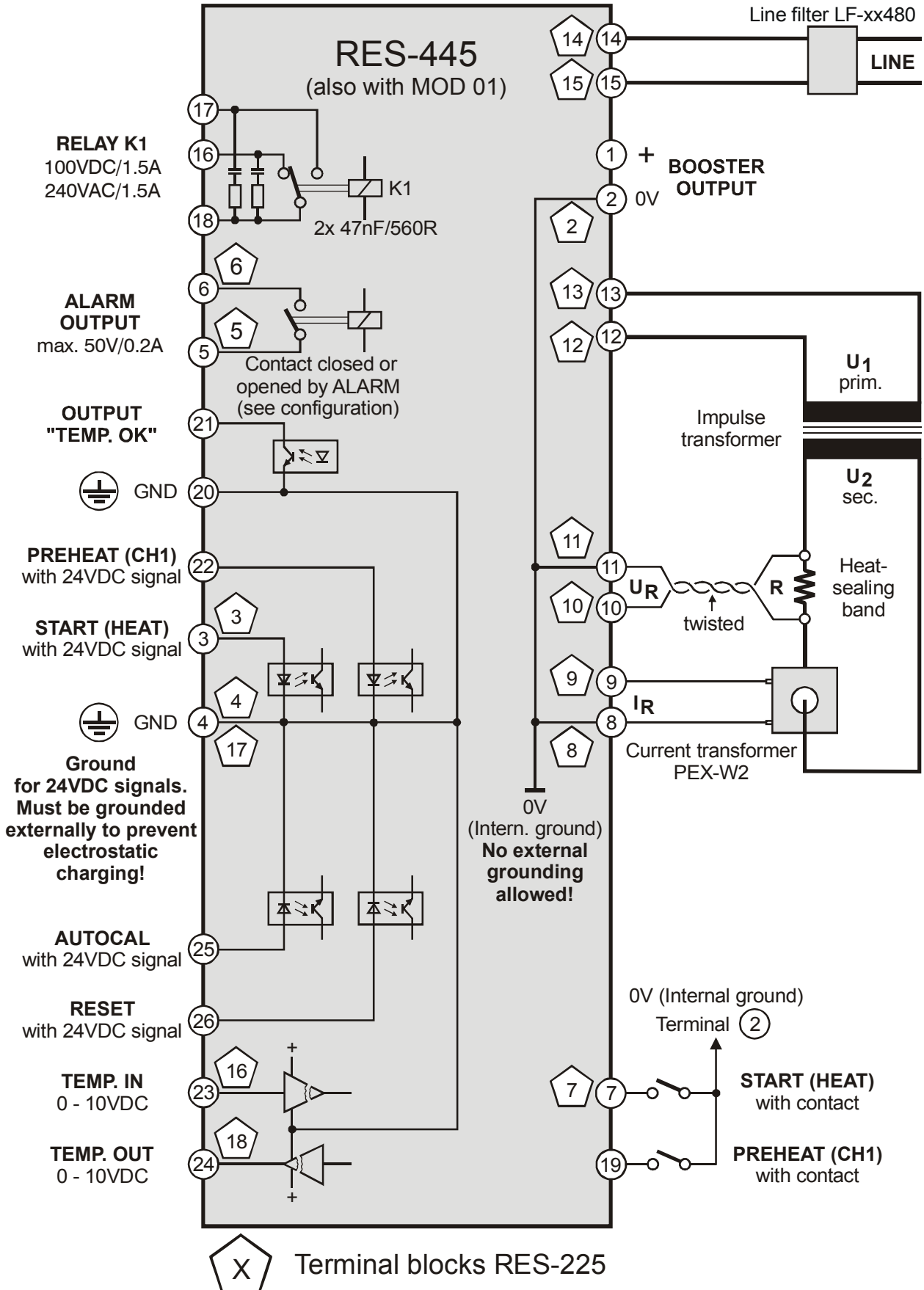

Menu structure of the RES-445

